

Marchio / Brand ZUCCHETTI

PAN

## PAN









ZP6247.195E

Single lever basin mixer with extended spout.



Single lever basin mixer with extended spout, aerator, pop-up waste, flexible hoses. Spout projection 6 1/2". Water flow restrictor.

### Finiture / Finishes

	 C3	 C8	 C40	 C41	 C50	 C51
Chrome	Brushed Nickel	Polished Nickel	Gold	Brushed Gold	Metal Black	Brushed Metal Black
	 N1	 N7				
Embossed Matt White	Embossed Matt Black	Soft Touch Black				

## PAN

ZP6247.195E Disegno Complessivo / Overall Drawing

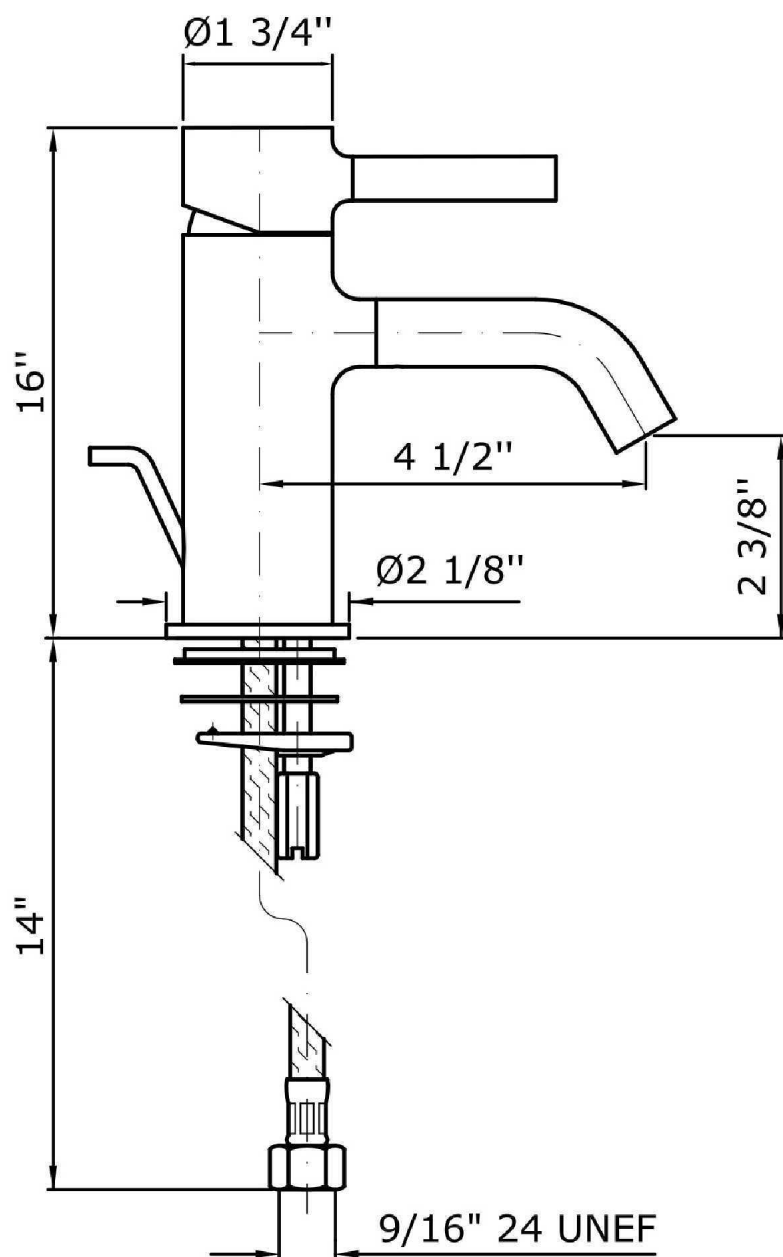

## PAN

ZP6247.195E      Esplosi / Exploded

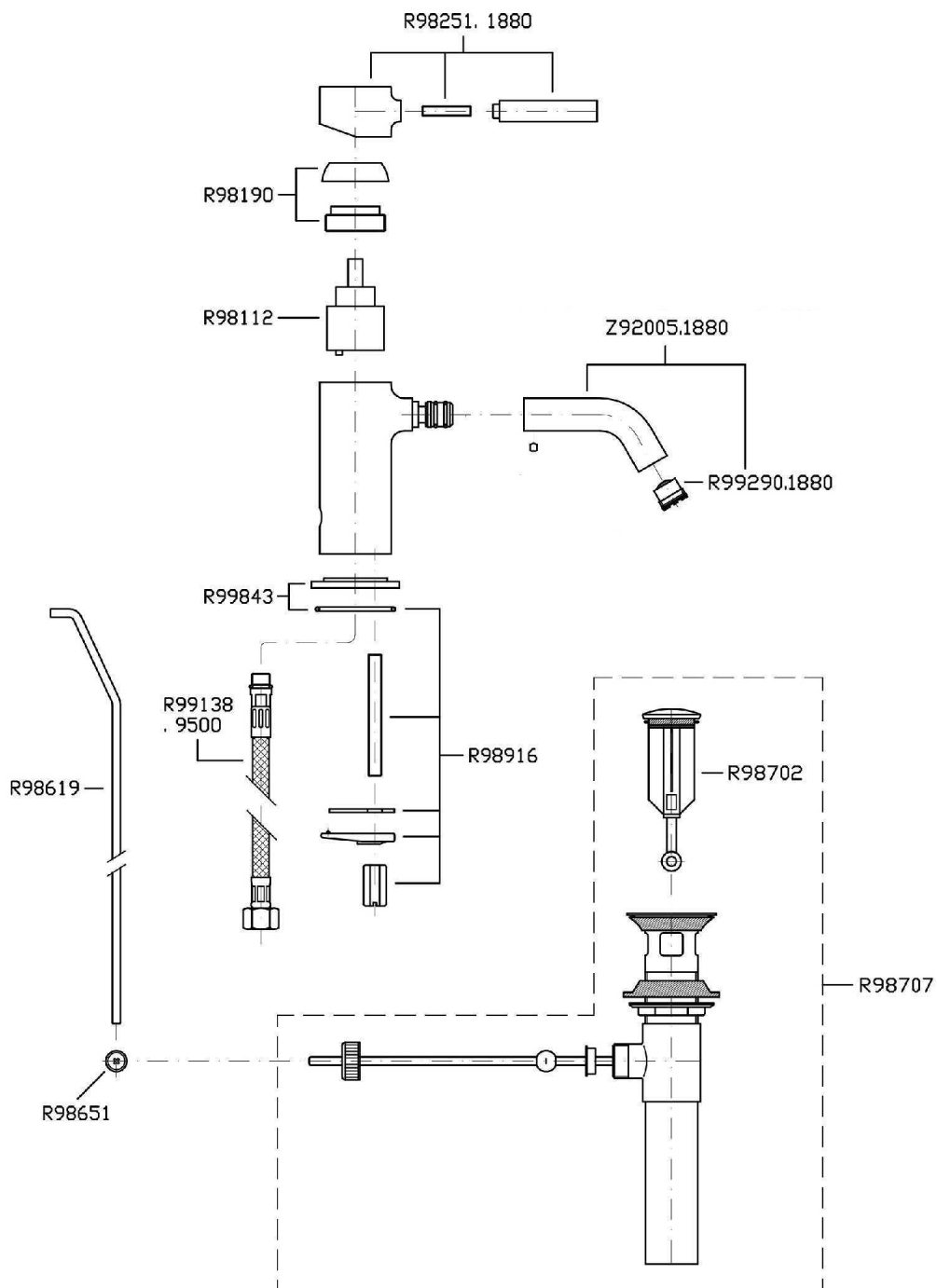

Marchio / Brand ZUCCHETTI

PAN

## PAN

ZP6247.195E Certificazioni / Certifications

USA

IAPMO

## PAN

ZP6247.195E Pesì e Misure / Weights and Sizes

Peso ( Kg ) Weight ( lb )	2,40 ( Kg )	5,29 ( lb )
Volume test ( dc3 ) - ( in3 )	7,43 ( dc3 )	453,41 ( in3 )
h ( mm ) - ( in )	90,00 ( mm )	3,54 ( in )
L1 ( mm ) - ( in )	250,00 ( mm )	9,84 ( in )
L2 ( mm ) - ( in )	330,00 ( mm )	12,99 ( in )

